



# XEKPT-08EU-C.0

English	Technical data
01 Power	1.2 kW   4094 BTU/h
02 Frequency	50 / 60 Hz
03 Electric nominal heat input	1.2 kW   4094 BTU/h
06 Power supply cable type	H07RN-F
07 Voltage	220-240V ~1PH+N+PE
Power cable section	3G x 1,5 mm <sup>2</sup>
Current	I1 5.5 A
08 Cable	✓   Schuko
11 Water pressure	150-600 kPa   22-87 psi
12 Water max. consumption (steam)	NaN l/h @ 200 kPa   NaN gal/h @ 29 psi
14 Max. food load	40 kg   88 lbs
15 Max. temperature	50 °C   122 °F
14 IP protection class	X4

Italiano
01 Potenza
02 Frequenza
03 Potenza termica nominale elettrica
06 Tipo cavo alimentazione
08 Cable
11 Pressione acqua
12 Consumo max acqua (vapore)
14 Max. peso pieno carico
14 Grado protezione IP
15 Temperatura max.

Espanol
01 Potencia
02 Frecuencia
03 Potencia térmica nominal eléctrica
06 Tipo de cable de alimentación
08 Cable
11 Presión del agua
12 Consumo máximo de agua (vapor)
14 Carga máxima de alimentos
14 Grado de protección IP
15 Temperatura máxima

Français
01 Puissance électrique
02 Fréquence
03 Puissance calorifique nominale électrique
06 Type de câble d'alimentation
08 Cable
11 Pression de l'eau
12 Consommation max. d'eau (vapeur)
14 Charge max. des aliments
14 Niveau de protection IP
15 Température max.

Deutsch
01 Elektrische Leistung
02 Frequenz
03 Elektrische Nennwärmeleistung
06 Stromkabel Typ
08 Cable
11 Wasserdruck
12 Maximaler Wasserverbrauch bei Damfbetrieb
14 Maximale Beladungskapazität
14 IP-Schutzart
15 Maximale Temperatur

Terms and conditions of installations - Observe all local specific standard and regulations for installation and operations.



Русский
01 Мощность
02 Частота
03 Номинальная электрическая потребляемая мощность
06 Тип силового кабеля
08 Cable
11 Давление воды
12 Максимальное потребление воды (пар)
14 Максимальная загрузка
14 Класс защиты IP
15 Максимальная температура

中文
01 功率
02 频率
03 电额定热输入
06 电源电缆类型
08 Cable
11 水压
12 最大水消耗 (蒸汽)
14 最大食物负荷
14 IP保护等级
15 最高温度

Português
01 Potência
02 Frequência
03 Potência térmica nominal elétrica
06 Tipo de cabo de alimentação
08 Cable
11 Pressão da água
12 Max. consumo de água (vapor)
14 Max. capacidade de alimento
14 Grau de proteção IP
15 Max. temperatura

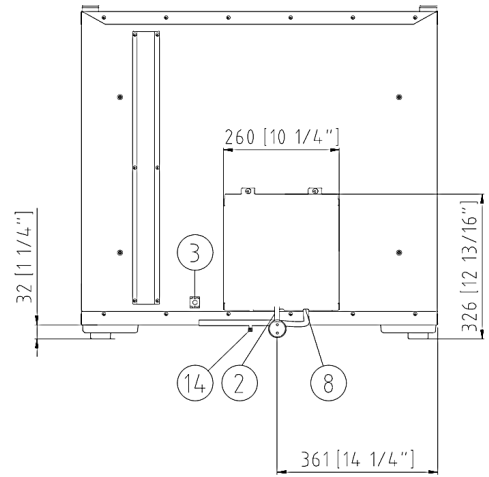
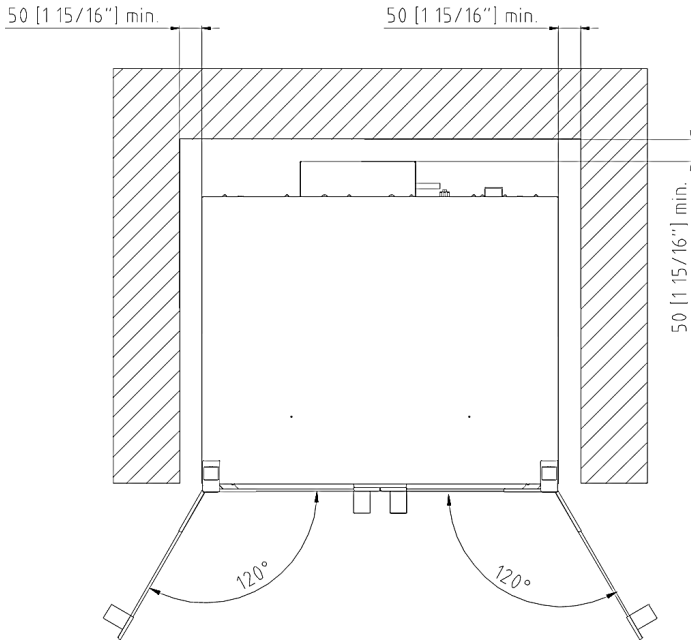
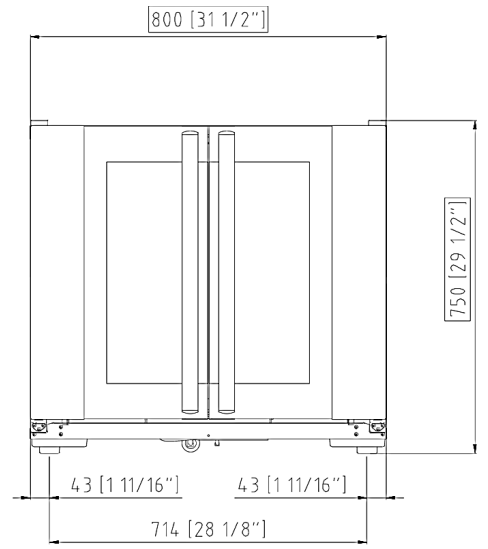
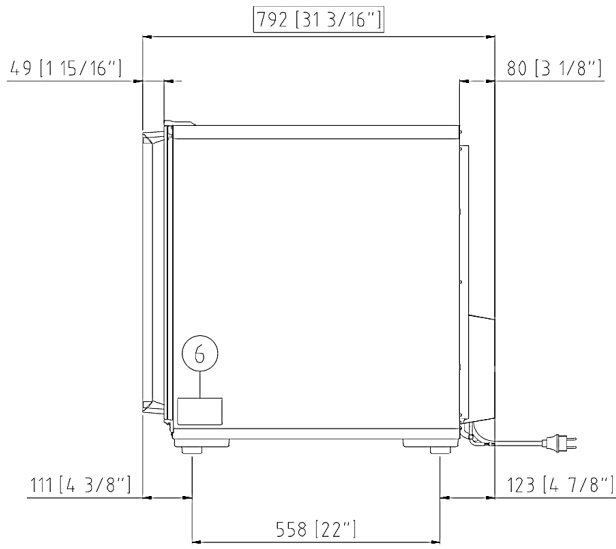

	English	Italiano	Español	Français	Deutsch
02	Electrical connection	Allacciamento elettrico	Conexión eléctrica	Raccordement électrique	Elektrischer Anschluss
08	Water connection	Allacciamento idrico	Conexión de agua	Raccordement à l'eau	Wasseranschluss
09	Gas connection	Allacciamento gas	Conexión de gas	Raccordement au gaz	Gasanschluss
11	Water drain	Scarico acqua	Desagüe del agua	Evacuation	Abflussrohr
12	Smoke exhaust	Scarico fumi	Salida de humos	Aspiration des fumées	Abluftrohr
13	Accessories connection	Collegamento accessori	Conexión de accesorios	Connexion des accessoires	Anschluss des Zubehörs
30	Combustion fumes	Fumi di combustione	Gases de combustión	Fumées de combustion	Abgasse
31	Air inlet	Ingresso aria	Entrada de aire	Entrée d'air	Lufteinlass
	Русский	中文	Português		
02	Электрическое подключение	电源连接	Conexão elétrica		
08	Подключение к воде	水连接	Conexão hídrica		
09	Подключение к газу	燃气连接	Conexão gás		
11	Выход воды	排水	Saída de água		
12	Выход газов	排烟	Saída de fumaça		
13	Подключение аксессуаров	配件连接	Conexão de acessórios		
30	Продукты горения	燃烧烟雾	Fumaça de combustão		
31	Воздухозаборник	空气入口	Entrada de ar		

